



**6DEPLOY**

IPv6 Protocol (headers & options)

**6DEPLOY. IPv6 Deployment and Support**

# Copy ...Rights

*This slide set is the ownership of the 6DISS project via its partners*

*The Powerpoint version of this material may be reused and modified only with written authorization*

*Using part of this material must mention 6DISS courtesy*

*PDF files are available from [www.6diss.org](http://www.6diss.org)*

*Looking for a contact ?*

- ***Mail to : [martin.potts@martel-consulting.ch](mailto:martin.potts@martel-consulting.ch)***
- ***Or [bernard.tuy@renater.fr](mailto:bernard.tuy@renater.fr)***



## Droits d'auteur ...

*L'ensemble des présentations utilisées dans le cadre de cet atelier est la propriété de 6DISS, représenté par ses différents partenaires.*

*La version Powerpoint des présentations peut être réutilisée et modifiée après qu'une autorisation écrite ait été obtenue*

*L'usage de tout ou partie de ce matériel doit mentionné que sa source est le projet 6DISS*

*La version PDF des présentations est disponible sur [www.6diss.org](http://www.6diss.org)*

*Pour tout contact :*

- *Mail à [Martin.Potts@martel-consulting.ch](mailto:Martin.Potts@martel-consulting.ch)*
- *Ou [Bernard.Tuy@renater.fr](mailto:Bernard.Tuy@renater.fr)*

## Contribs

B. Tuy, RENATER

L. Toutain, ENST-B



# Updates

B. Tuy 20/05/2008



# Agenda

## IPv6 Header

- Comparison with IPv4

## IPv6 optional headers (extensions)

## Processing IPv6 headers

- Comparison with IPv4

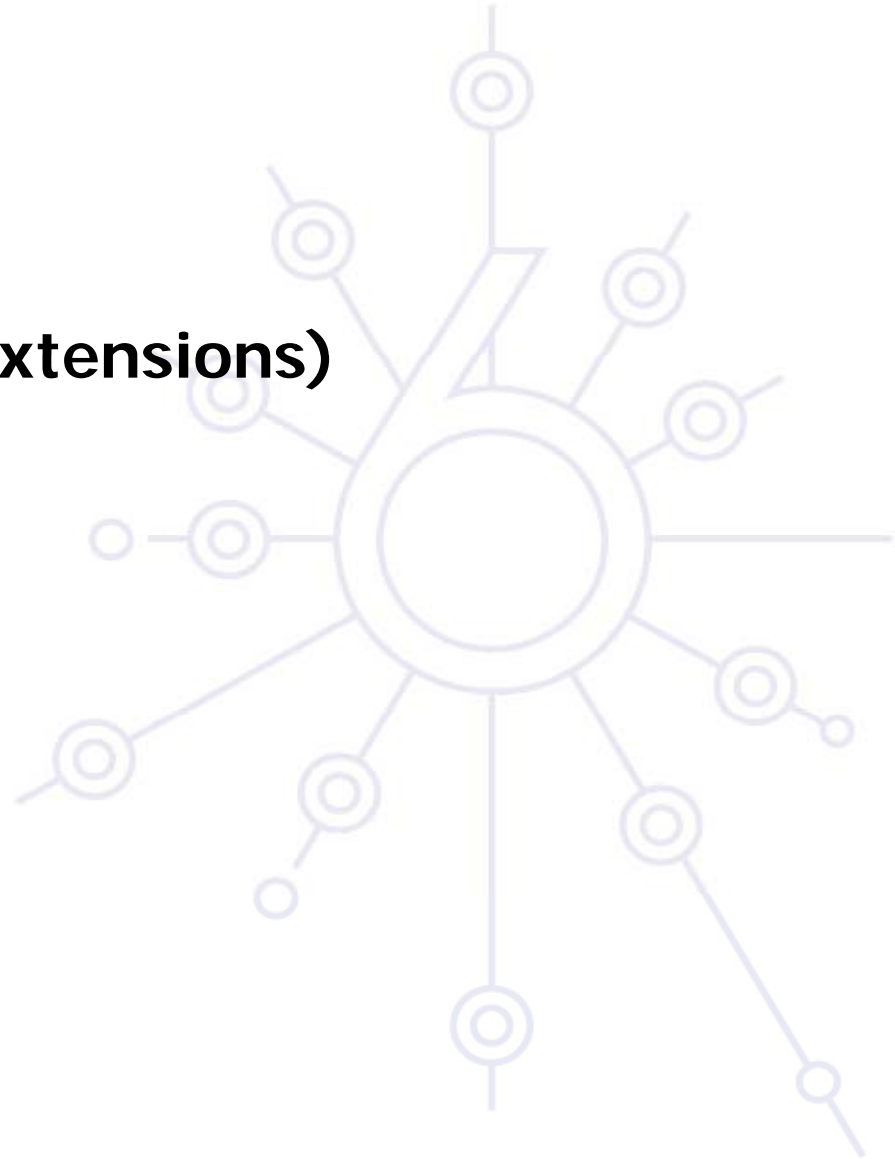

# IPv6 Header

## The IPv6 header is designed

- To minimize header overhead
- and reduce the header process for most of the packets
- Less important information and option fields are moved to *extension headers*

⇒ **IPv6 & IPv4 headers are not interoperable**

# IPv4 Header

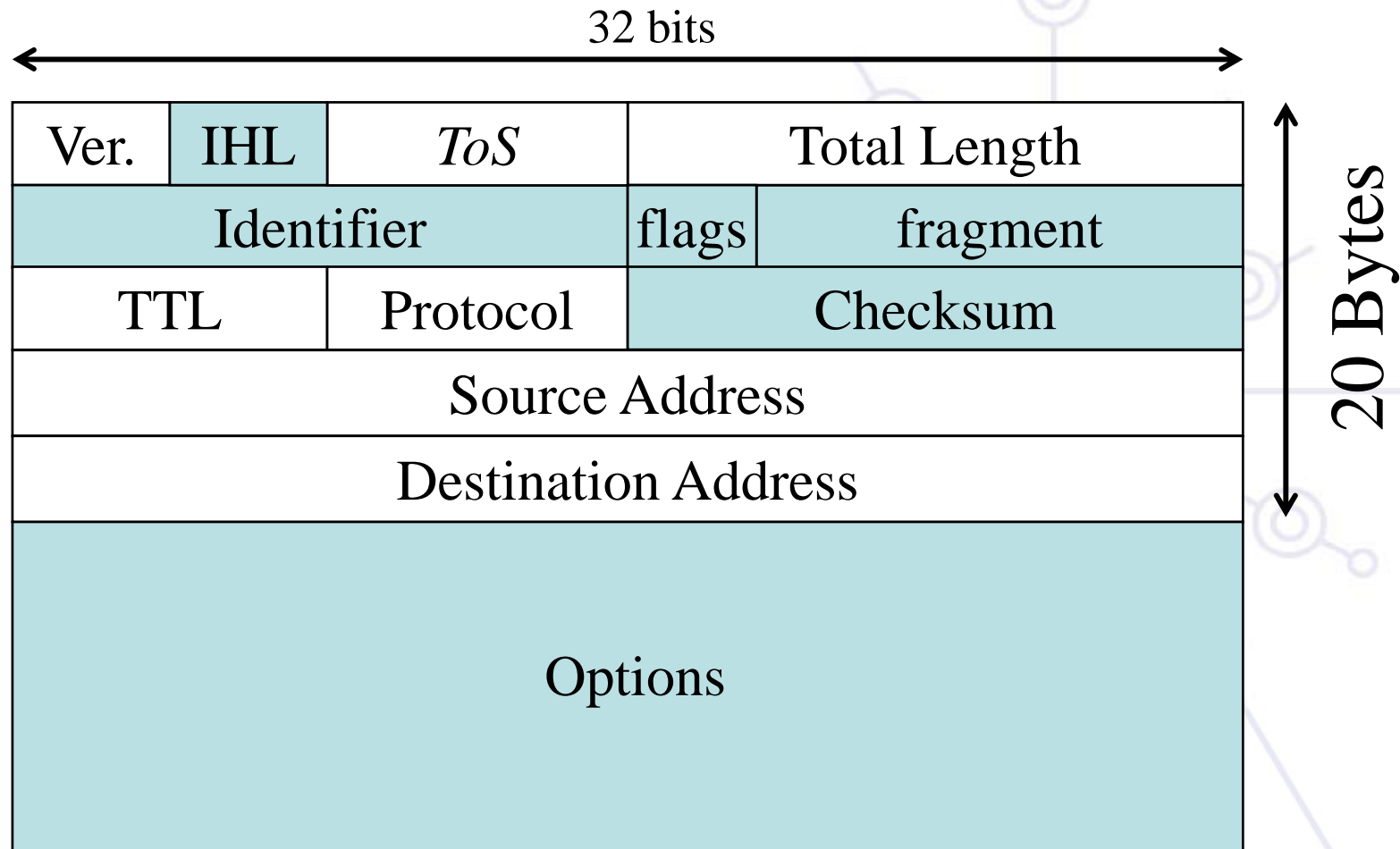



# IPv6 Header simplification

32 bits

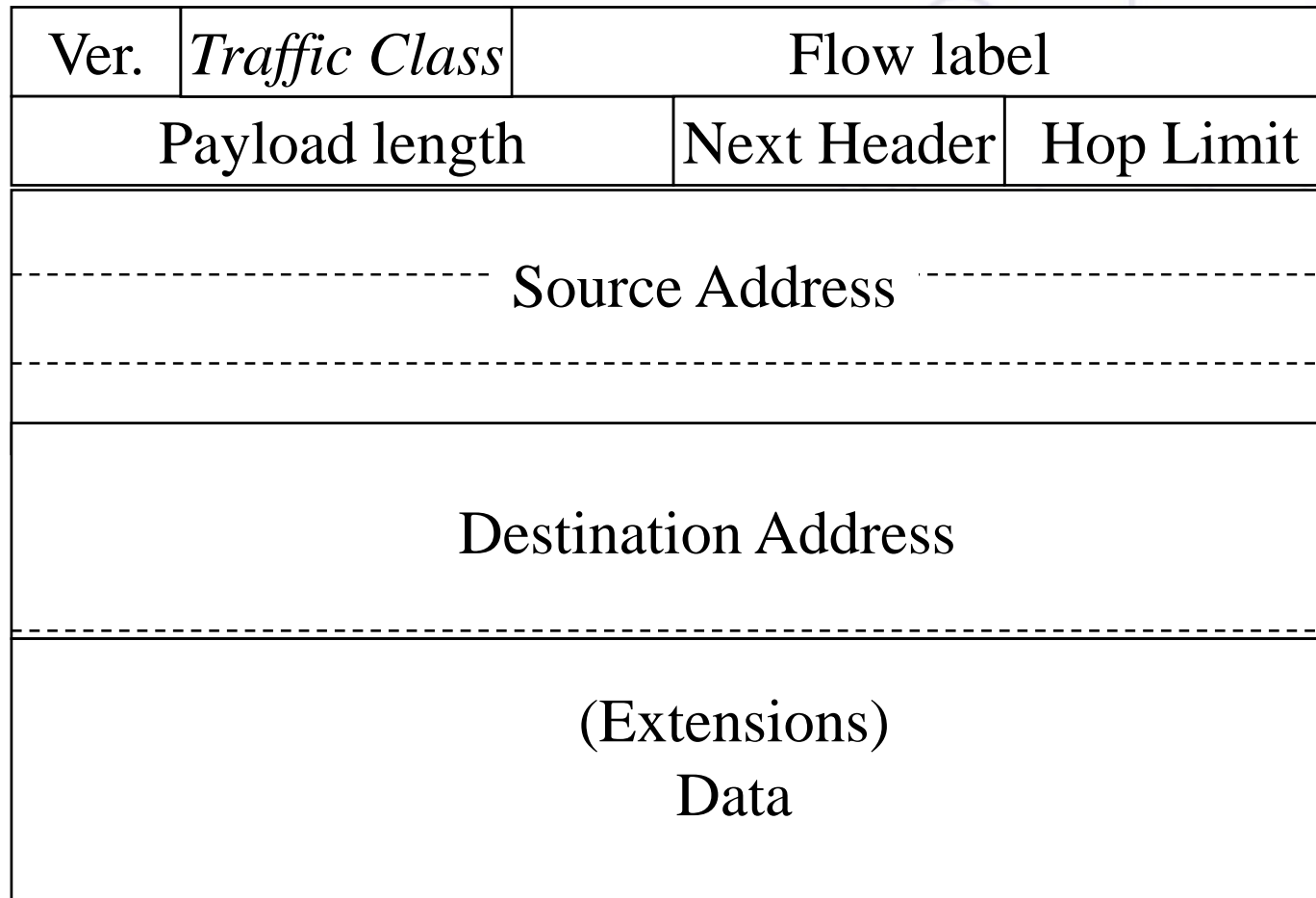
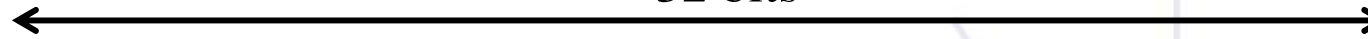

40 Bytes

# IPv6 header fields

## Version

- 4 bits

## Traffic class (*see next slide*)

- 8 bits

## Flow label (*see next slide*)

- 20 bits

## Payload length

- Use Jumbogram for specific cases (payload = 0)
- 16 bits

## Hop limit

- 8 bits

## Next header

- 8 bits

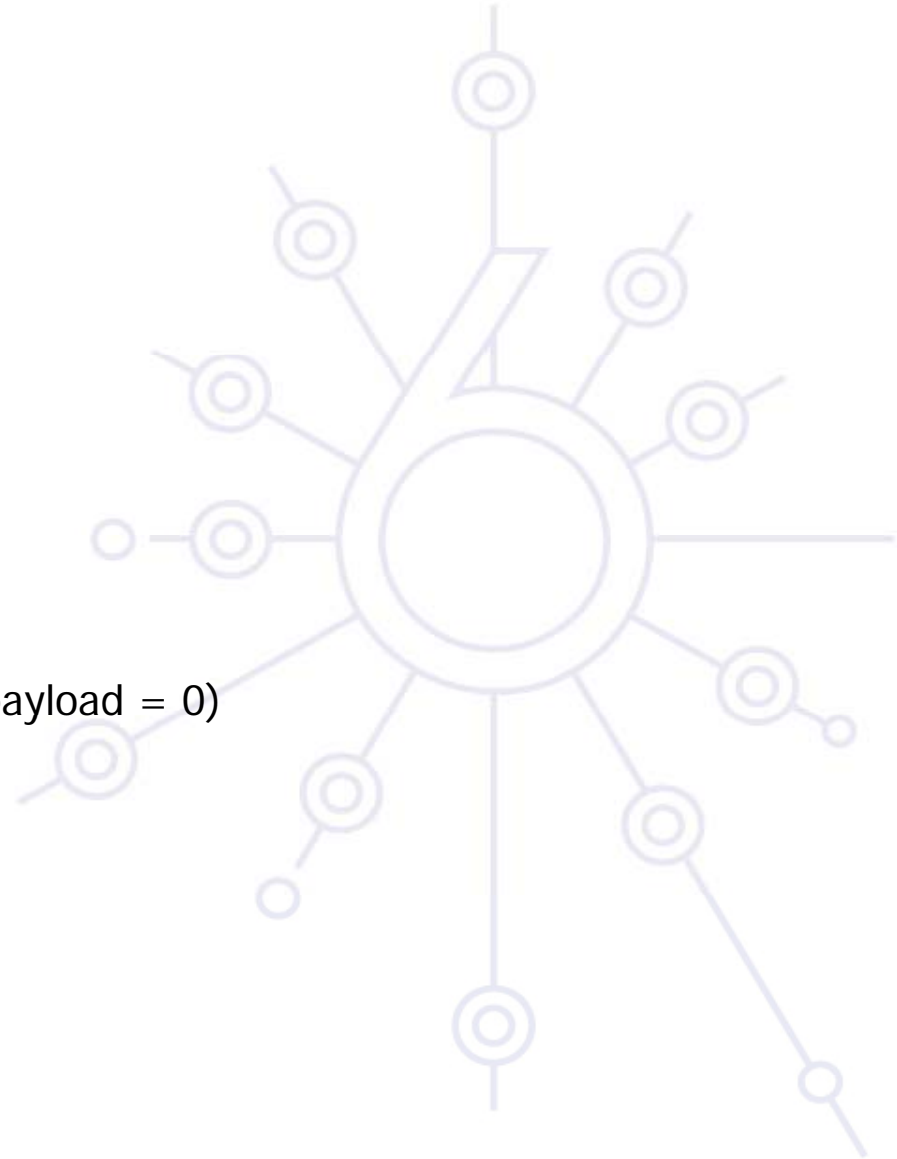

# CoS support in IPv6

## The Traffic Class field: *used as in IPv4*

- Work done in diffserv wg (closed): RFCs **2474**, 2475, 2597, 3260, ...



CU is Currently Unused (reserved)

## The Flow Label field: designed to enable classification of packets belonging to a specific flow

- **A flow** is a sequence of packets that should receive specific non-default handling from the network
- Intuitively: 5-tuple of the same source/destination address/port and transport protocol values
- Without the flow label the classifier must use transport next header value and port numbers
  - Less efficient (need to parse the option headers)
  - May be impossible (fragmentation or IPsec ESP)
- Further info:
  - RFC 3697 (PS)

# IPv6: optional Extensions

New “mechanism” replacing IPv4 options

## An IPv6 extension :

- Every extension has its own message format
- Is a  $n \times 8$ -byte datagram
- Starts with a 1-byte ‘Next Header’ field
  - Pointing to either another extension or a L-4 protocol

## Hop-by-hop (**jumbogram, router alert**)

- Always the first extension
- Analyzed by every router.

## Destination

## Routing (*loose source routing*)

## Fragmentation

## Security

- Authentication (AH)
- Encapsulating Security Payload (ESP) : confidentiality

## Order is important (RFC 2460)

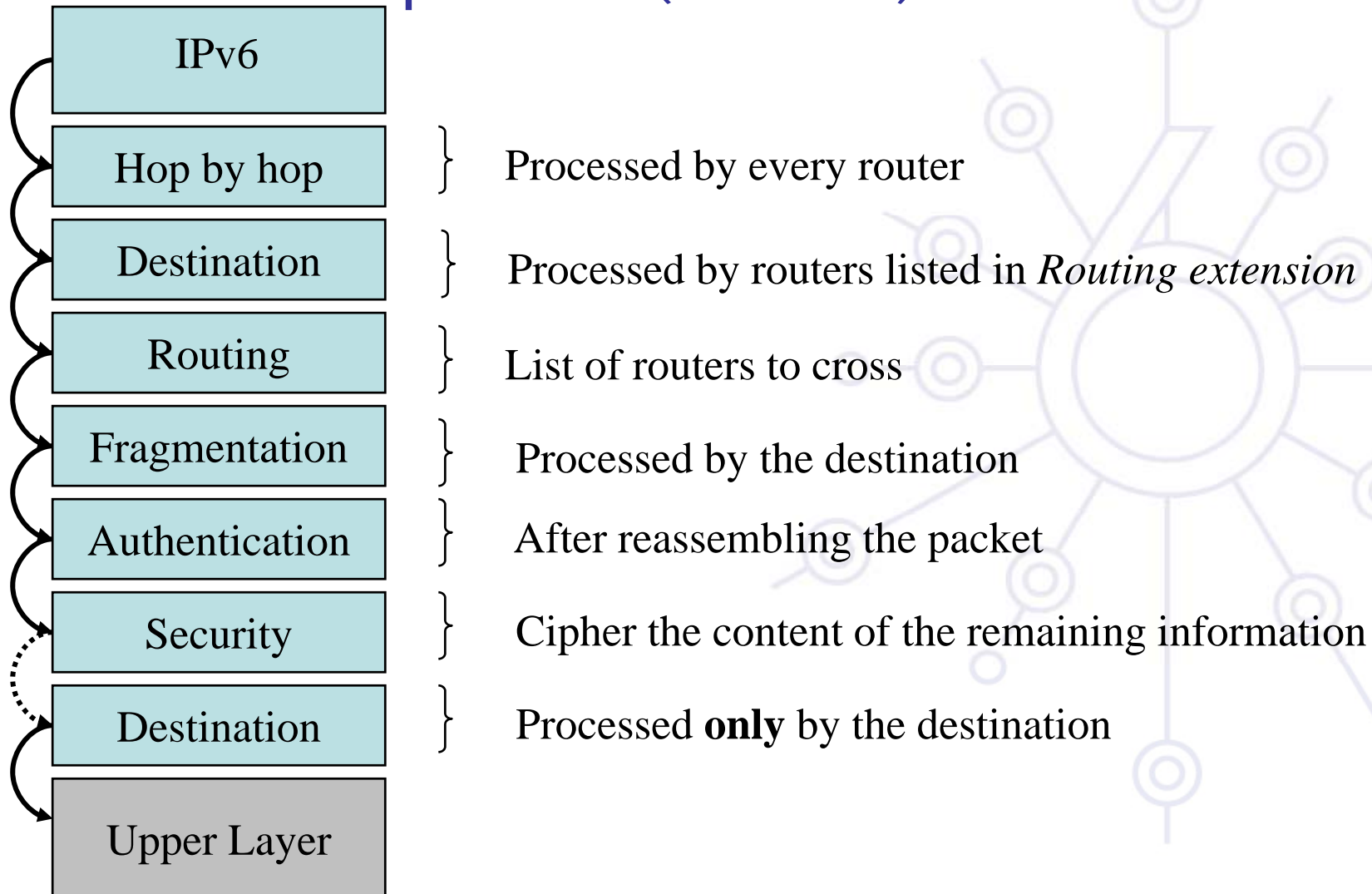

# IPv6: Optional headers

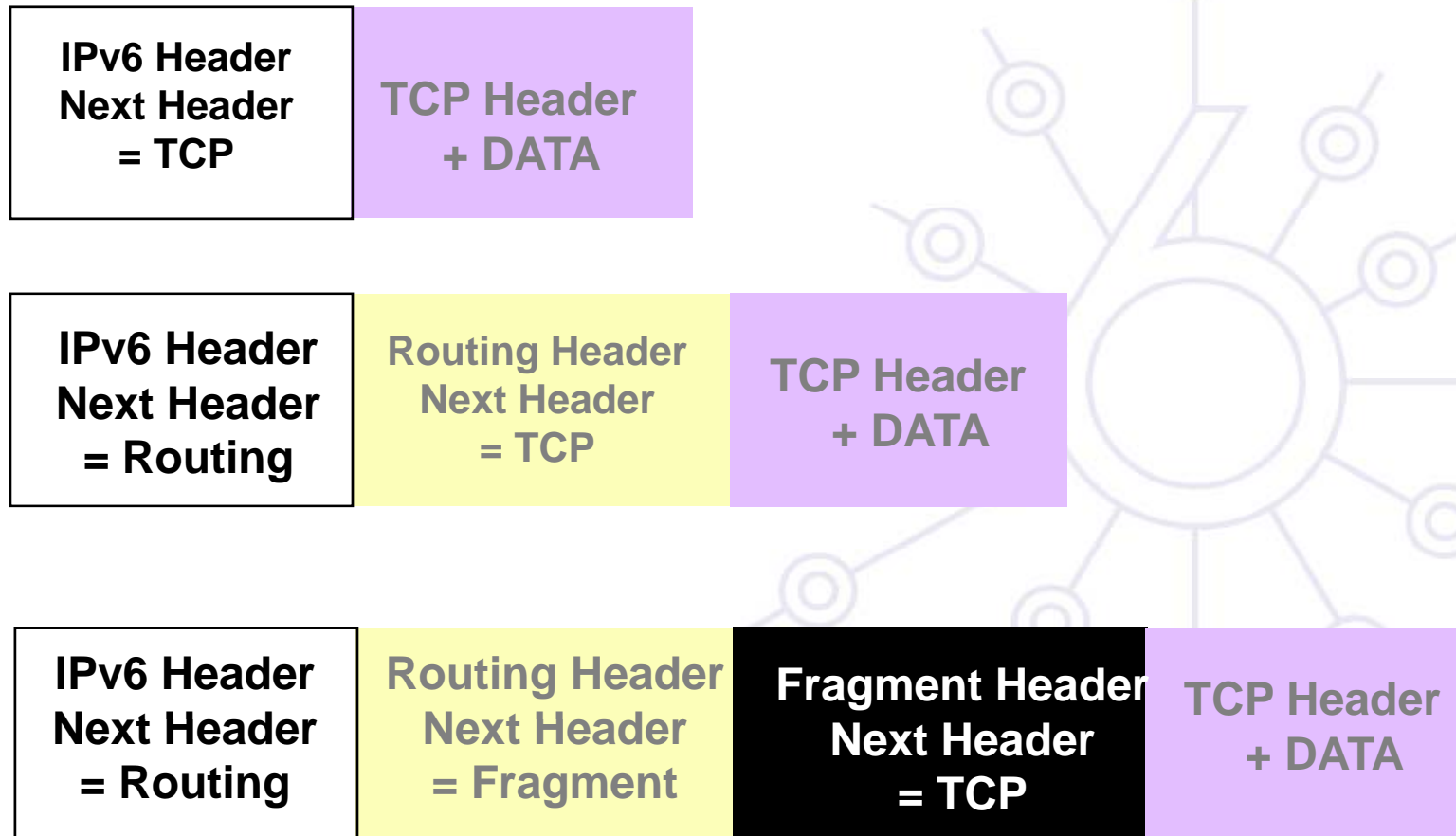

# IPv4 header options processing

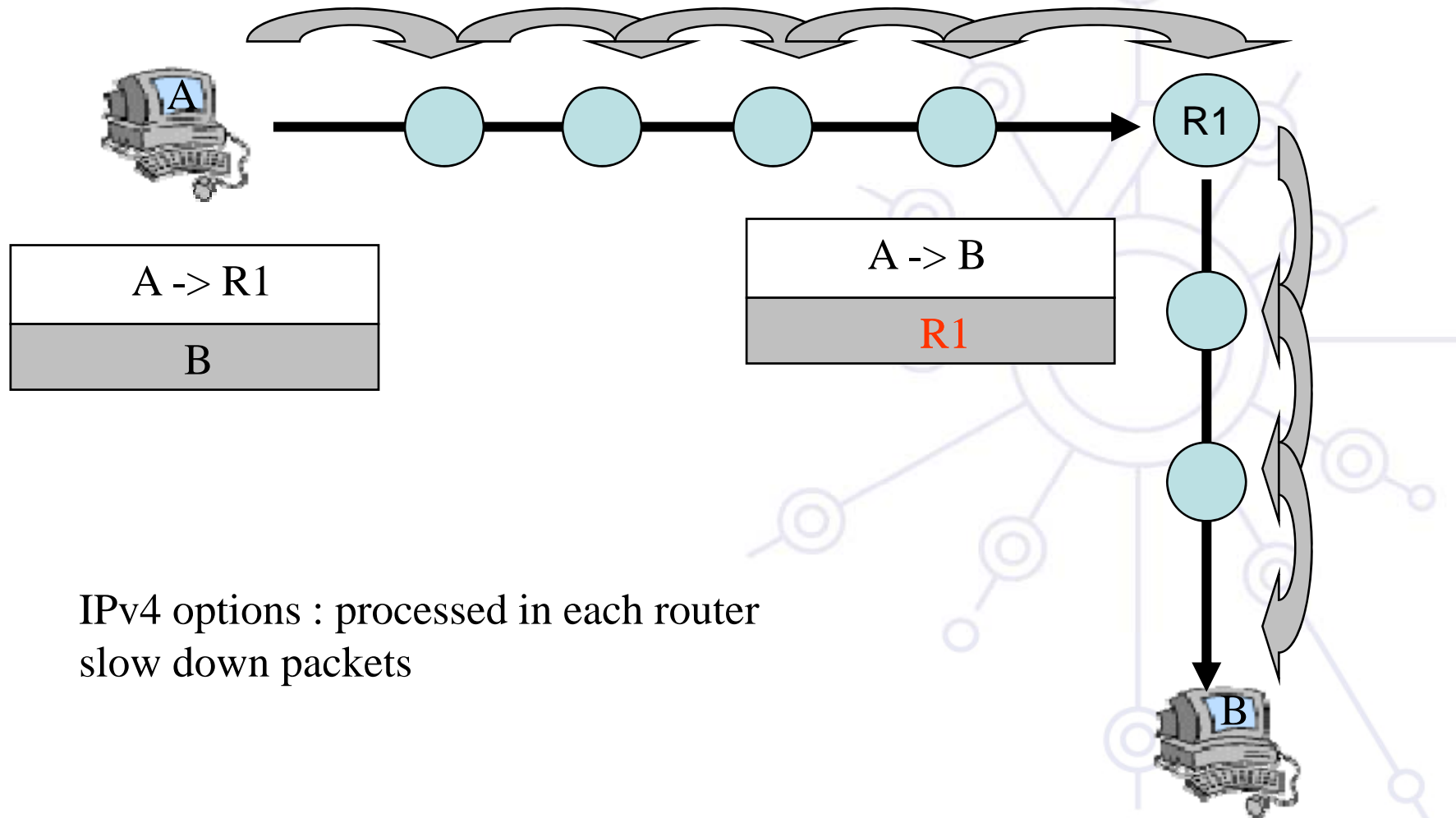

IPv4 options : processed in each router  
slow down packets

# IPv6 ext. header processing

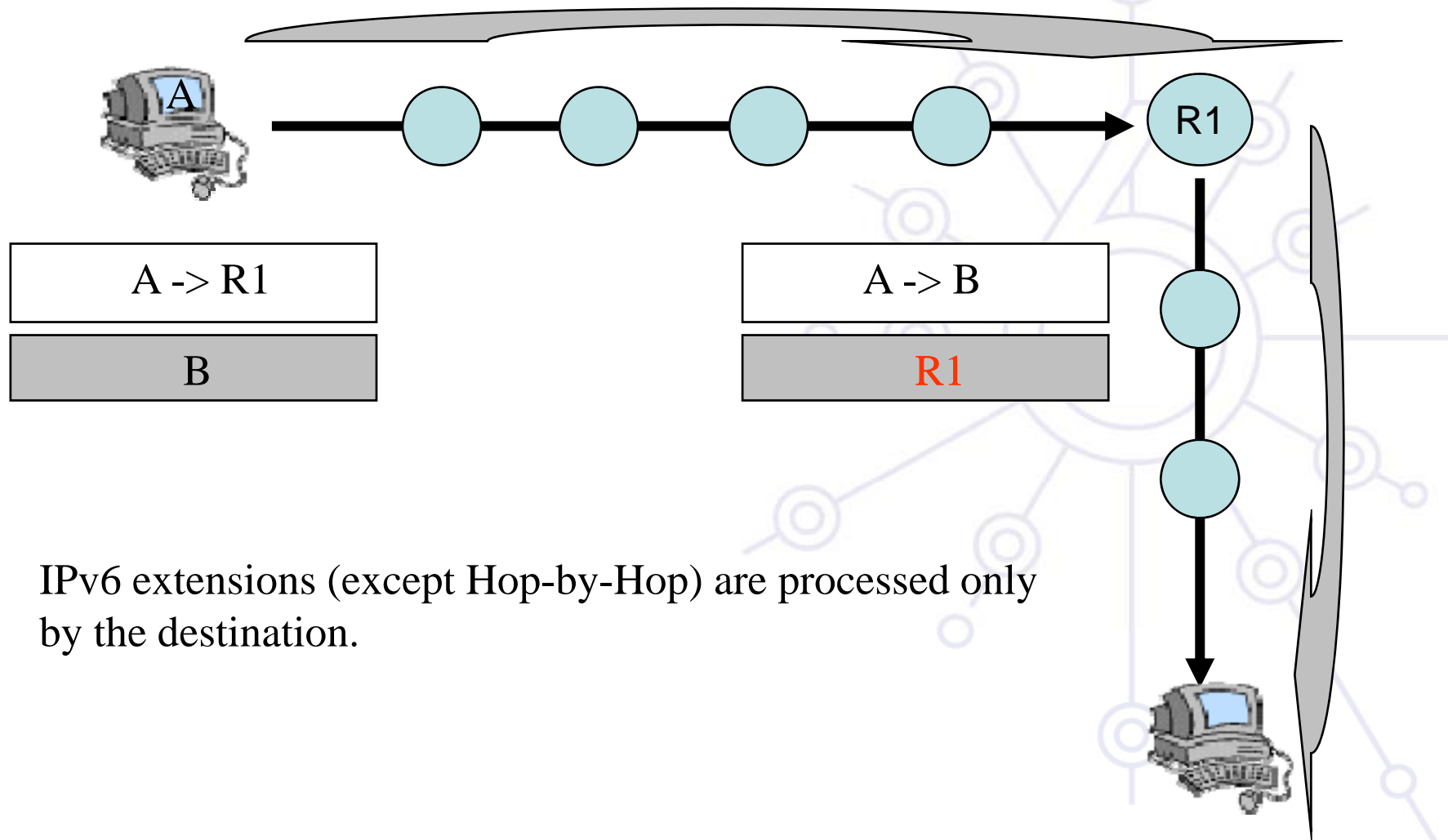

IPv6 extensions (except Hop-by-Hop) are processed only by the destination.



## Conclusion

Main changes in IPv6 protocol are within address format and datagram headers

- **A lot of fields in the IPv6 header have disappeared**
  - ⇒ More efficient processing in the (intermediate) routers
- **Optional extensions allow more functionalities (source routing, authentication, ...)**
- **Optional header mechanism allows new options introduction without modifying the protocol**



deploy

Questions ...